

GENERATING SETS

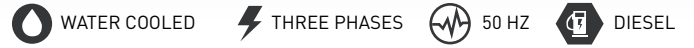

Service		Standby	Prime
Power	kVA	275	250
Power	kW	220	200
Rated Speed	r.p.m		1500
Standart Voltage	V		400 / 230
Rated At Power Factor	Cos Phi		0,8

GUCBIR Company with quality certification ISO 9001

GUCBIR gensets are compliant with EC mark which includes the following directives:

- 2006/42/CE Machinery safety.
- 2014/30/UE Electromagnetic compatibility.
- 2014/35/UE electrical equipment designed for use within certain voltage limits
- 2000/14/EC Sound Power level. Noise emissions outdoor equipment. (amended by 2005/88/EC)
- 97/68/EC Emissions of gaseous and particulate pollutants. (amended by 2002/88/EC & 2004/26/EC)
- EN 12100, EN 13857, EN 60204

Ambient conditions of reference according to ISO 8528-1:2005 normative: 1000 mbar, 25°C, 30% relative humidity.

G2 class load acceptance in accordance with ISO 8528-5:2013



+90 216 312 7979

info@gucbirjenerator.com

GUCBIR JENERATOR SAN. ve TIC. LTD. ŞTİ.

Turgut Özal Bulvarı No:139/3 Taşdelen - Çekmeköy / İSTANBUL

T: +90 216 312 79 79 | F: +90 216 312 79 77

info@gucbirjenerator.com | www.gucbirjenerator.com

SPECIFICATIONS

**VOLVO
PENTA**

Engine

M maranello
alternator

Alternator

Engine

Prime

Rated Output	kW	238
Manufacturer		VOLVO
Model		TAD734GE
Fuel Consumption Full Load	g/kWh	217
Aspiratiron		Turbo ACC
Number of cylinder		6
Bore and Stroke	mm	108x130
Displacement	L	7,15
Cooling System		Water Radiator
Governor Type		Electronic
Fuel Consumption 50% PRP	l/h	27,40
Fuel Consumption 75% PRP	l/h	38,27
Fuel Consumption 100 % PRP	l/h	47,98
Fuel Consumption Standby	l/h	57,10
Total oil capacity including tubes, filters	L	34
Total coolant capacity	L	34
Voltage	V	24
Battery Capacity	A	2X105A

Alternator

Specitications

Manufacturer		Maranello
Model		M275
Output Voltage	V	230/400
Frequency	HZ	50
Automatic Voltage Regulation	±%	0,5
Alternator Stand By Power	kVA	275
Alternator Continuous Power	kVA	250
Power Factor	Cosq	0,8
Number of Wires		12
Winding		2/3
Protection Class		IP23 / H
Excition System		Self-Excited
AVR Model		SX440
Performance - PF 0,8 / %75 Load	%	93,5

Prime Power (PRP):

According to ISO 8528-1:2005, Prime power is the maximum power which a generating set is capable of delivering continuously whilst supplying a variable electrical load when operated for an unlimited number of hours per year under the agreed operating conditions with the maintenance intervals and procedures being carried out as prescribed by the manufacturer. The permissible average power output (Ppp) over 24 h of operation shall not exceed 70 % of the PRP.

Emergency Standby Power (ESP):

According to ISO 8528-1:2005, Emergency standby power is the maximum power available during a variable electrical power sequence, under the stated operating conditions, for which a generating set is capable of delivering in the event of a utility power outage or under test conditions for up to 200 h of operation per year with the maintenance intervals and procedures being carried out as prescribed by the manufacturers. The permissible average power output over 24 h of operation shall not exceed 70 % of the ESP

Note:

All data based on operation to ISO 3046/1, BS 5514 and DIN 6271 standard reference conditions



+90 216 312 7979

info@gucbirgenerator.com

GUCBIR JENERATOR SAN. ve TIC. LTD. ŞTİ.

Turgut Özal Bulvarı No:139/3 Taşdelen - Çekmeköy / İSTANBUL

T: +90 216 312 79 79 | F: +90 216 312 79 77

info@gucbirgenerator.com | www.gucbirgenerator.com

DIMENSIONS

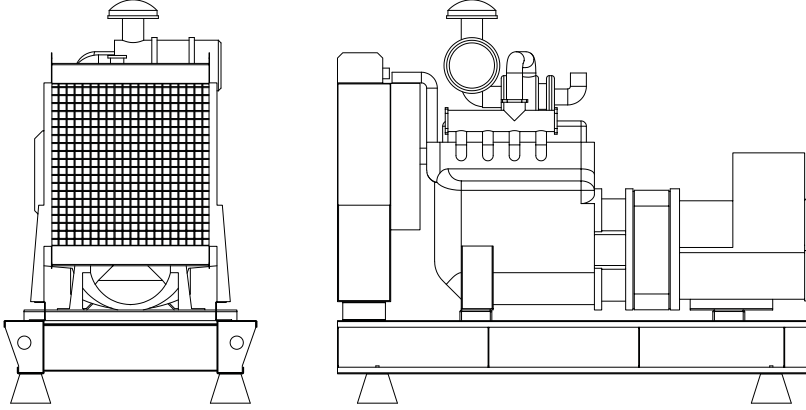

OPEN SET

LxWxH	mm	3000x1250x1800
Weight	kg	2500
Fuel Tank	lt	500

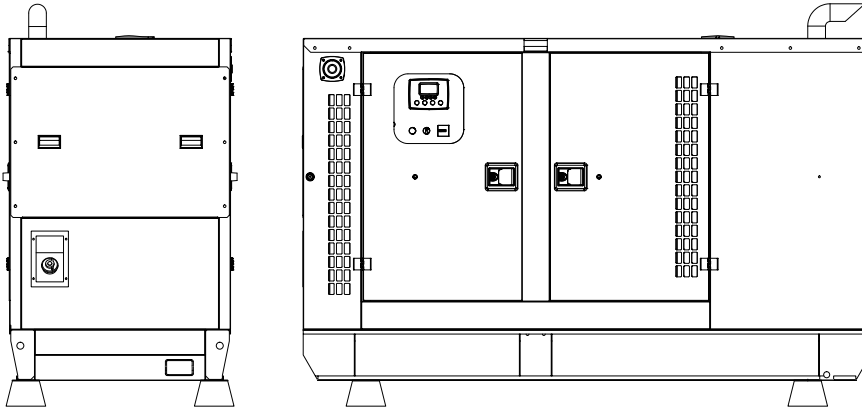

CANOPIED

LxWxH	mm	3400x1100x1960
Weight	kg	3490
Fuel Tank	lt	500

Sound Proof Canopy

- Special design for minimizing acoustic level.
- Galvanized steel construction further protected by polyester powder coat paint.
- Black finish stainless steel locks and hinges.
- Control panel viewing window in a lockable access door.
- Emergency stop push button (red) mounted on enclosure exterior.
- Lifting, drag and jacking points on base frame.
- Radiator fill via removable, flush mounted rain cap fitted with compression seal.
- Acoustic insulation with moisture-repellent and non-flammable material



+90 216 312 7979

info@gucbirgenerator.com

GUCBIR JENERATOR SAN. ve TIC. LTD. ŞTİ.

Turgut Özal Bulvarı No:139/3 Taşdelen - Çekmeköy / İSTANBUL

T: +90 216 312 79 79 | F: +90 216 312 79 77

info@gucbirgenerator.com | www.gucbirgenerator.com

CONTROL UNIT

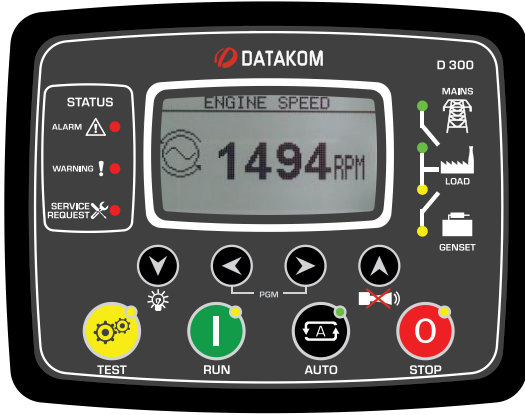

Control Unit

D300 - DATAKOM

4-band GPRS modem (optional)	Internet Central Monitoring
USB Device	SMS message sending
RS-232 (2400-57600baud)	E-mail sending
J1939-CANBUS	Free PC software: Rainbow Plus
Geo-locating through GSM	Modbus RTU
GPS support (RS-232)	

ATS PANEL

GUCBIR automatic transfer switches are reliable, rugged, versatile, and compact assemblies for transferring essential loads and electrical distribution systems from one power source to another. GUCBIR's contactor-based transfer switch is rated 40-3600A and can be supplied in separate enclosures for stand-alone applications or can be supplied as an integral component. Contactors inside the ATS panels are well known and internationally recognized brands such as ABB, SCHNEIDER, HYUNDAI and ANDELI.



OPTIONAL EQUIPMENTS

Some Optional Equipments that GUCBIR provides with Generator Sets;

- Medium voltage alternator,
- Remote radiator applications,
- Automatic fuel filling system,
- Fuel tank, oil pan, dashboard, alternator, coil heaters,
- Alternator with double AVR and PMG,
- Synchronization systems, The generator output breaker,
- Grid-generator transfer switches,
- Accordance with the specific volume of demand-insulated cabins,
- Seismic solutions,
- Trailer,
- Remote monitoring.
- SMPS 12/24V 10A

Control Panel

- Datakom D500
- Datakom D700
- ComAp AMF9
- ComAp AMF25



+90 216 312 7979

info@gucbirjenerator.com

GUCBIR JENERATOR SAN. ve TIC. LTD. ŞTİ.

Turgut Özal Bulvarı No:139/3 Taşdelen - Çekmeköy / İSTANBUL

T: +90 216 312 79 79 | F: +90 216 312 79 77

info@gucbirjenerator.com | www.gucbirjenerator.com